

Installation Instructions for Fender Bracket Kit 10001388



Document #10005037, Revision A
Brackets are Compatible with Models:
MIN950, MIN1550 & MIN4050.

STEP 1 - IDENTIFY PARTS

- A. Lay out parts and hardware packs.
- B. Compare the parts and hardware with bracket kit 10001388 as shown in **Figure 1**.

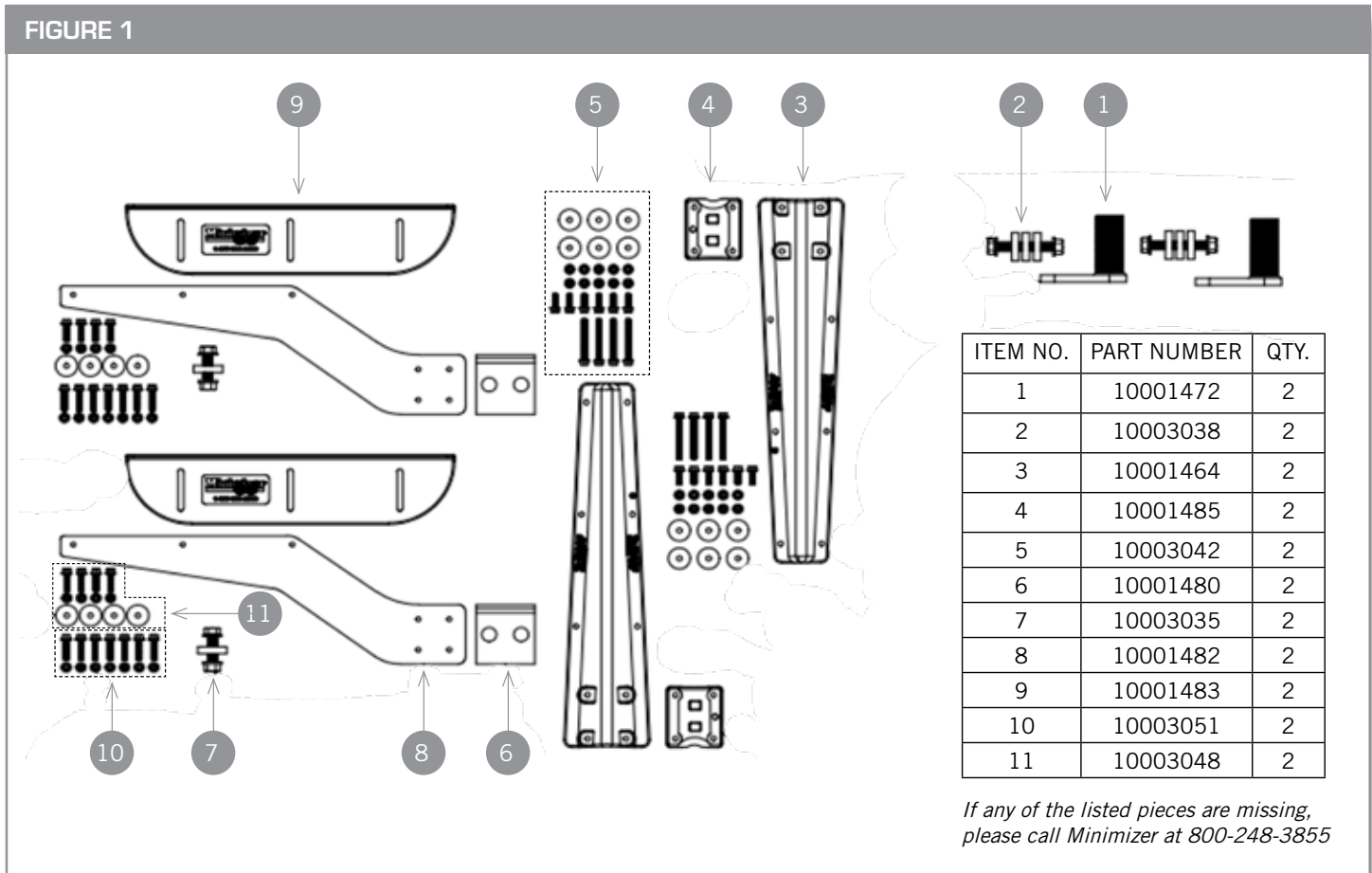

STEP 2 - DETERMINE SIZE OF SPACERS AND POSITION FENDERS

- A. Confirm the total suspension travel distance. This is used to determine the clearance required between the fender and the tire.
 - a. For air suspension systems, dump the air bags and confirm it is the lowest point of travel.
 - i. Understand that some air suspension designs may cause the wheels to roll closer to the fender (roll forward) as the suspension deflates. In order to make sure the fenders are centered on the tires, test the suspension in the inflated and deflated positions to determine the best positioning so that the fenders are centered over the tires in the inflated position.
 - ii. For **air suspensions with travel exceeding 6"**, a travel stop may need to be installed to reduce required clearance between the fenders and tires.
This will also improve alignment and 5th wheel plate clearance.
(Please call Minimizer @ 800-248-3855 for questions regarding this issue).
 - b. For spring systems, measure the distance between the spring assembly and the bump stops on the frame and record the measurement.

- B. Place the fenders on spacer blocks above the tires.
 - a. In most applications 1.5" of tire clearance is best. The goal is to ensure the fender does not rub the tire.
 - i. The minimum clearance recommended is ¾" above the maximum travel point of the suspension system.
 - b. For an air suspension system, place a ¾" to 1.5" thick board on top of the tires after the air is released from the airbags. **(See Figure 2)**
 - c. For spring suspensions use spacer material that is ¾" to 1.5" thicker than the measurement recorded above.
- C. For trucks with air suspension, raise and lower the suspension to confirm the clearance between the fenders and wheels and that the fenders will be centered front to rear when the air suspension is inflated.

FIGURE 2

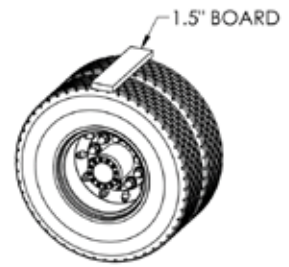

FIGURE 3

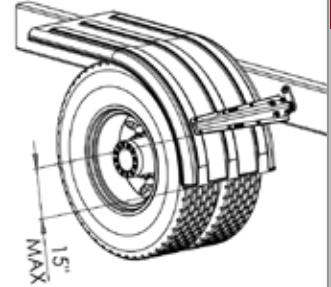
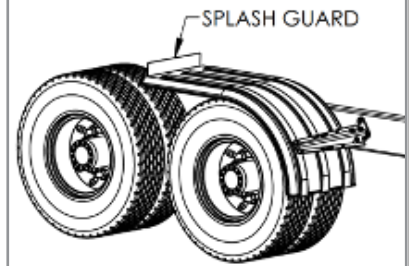

FIGURE 4



STEP 3 - POSITION BRACKETS

- A. With the fenders in position, mark and test fit the brackets where they will attach to the frame.
- B. If possible, use existing bolt holes in the frame to attach.

Tip: It is common for the front bracket to align with the existing quarter fender holes.
- C. If possible, position the mounting brackets low on the fender so they are no more than 15" from the bottom. **(See Figure 3)**
 - a. Brackets mounted 8-12" from the bottom is optimal.
 - b. The goal is to reduce the risk of the leading edge of the fender from blowing back against the tire during high wind.
 - c. Splash guards are available if additional coverage is desired with a half fender set. **(Part number 10003422) (See Figure 4)**

Tip: If the front fender bracket is mounted higher than 15", refer to the link below for further suggestions on adding additional support.
<http://www.minimizer.com/instructions.html>

NOTES:

- Round spacers are supplied to hold the (10001472) swivel bracket away from the frame when needed. In some cases, frame components may interfere with the required bracket location and require a spacer. **(See Figure 5)**
- **USE SPACERS ONLY WHEN NECESSARY!** The ideal installation is to mount the (10001472) swivel bracket directly to the frame using no spacers.
- If using the mounting hole inside the pipe of the swivel bracket, the excess flat steel maybe trimmed off to provide a cleaner look.
- D. Attach the (10001482) poly arms to the (10001480) metal brackets using four 5/16" x 1-1/2" bolts. **(See Figure 6)**

FIGURE 5

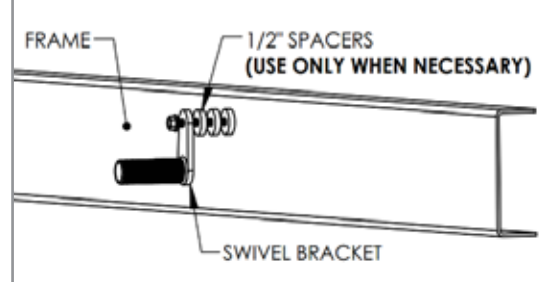
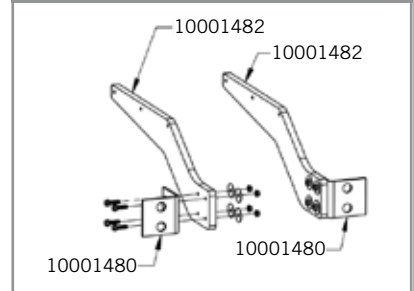

FIGURE 6



IMPORTANT INFORMATION:

- Assemble a left and right-hand arm assembly as shown in **Figure 6**.
- The bolt head **MUST** be located on the metal plate side. If not, the serration on the bottom of the bolt head will damage the poly arm.
- Tighten from the bolt head side so the nut does not spin on the poly arm.
- If the locknut is ever loosened after it has been tightened it is highly recommended to replace the locknut.
- **Recommended torque is 10-15 ft.-lbs.**

CAUTION: Overtightening hardware will damage the poly arm and could cause it to fail.

STEP 4 - ATTACH BRACKETS TO TRUCK FRAME

- A. Install the center bracket as close to the end of the fender as possible. If possible, use existing bolt holes in the frame to attach. Either hole in the bracket may be used.
(See Figure 7).
 - a. It is possible to remove any existing frame bolt and replace it with the supplied bolt in the bracket kit.
 - b. **Recommended torque is 160-170 ft.-lbs.**
- B. Once the front bracket is in position with the fender, tighten the 5/8" x 4-1/2" bolt that goes through the (10001472) swivel bracket to attach the swivel securely to the frame. **(See Figure 8)**
 - a. **Recommended torque is 160-170 ft.-lbs.**

STEP 5 - ASSEMBLE BRACKETS

- A. Place four 5/16" x 3" bolts through the (10001464) poly bracket and the (10001485) backing block to clamp the (10001472) swivel. **(See Figure 9)**
 - a. **Make sure the pipe of the (10001472) is fully inserted in the poly parts.**
- B. Install the nuts finger tight and align the bracket to the fender.
- C. Tighten the four bolts evenly as described below.
 - a. Do not completely tighten one corner of the backing block before moving to the next corner. Tighten each nut 30%-50% and move to the next nut following the pattern shown in **Figure 10**.
 - b. Repeat the tightening pattern 2-3 times until backing block is flush against the (10001464) poly bracket.
 - c. **Recommended torque is 10-15 ft.-lbs.**
 - i. ALWAYS SPIN THE NUT AND HOLD THE HEAD STATIONARY.
 - ii. DO NOT EXCEED RECOMMENDED TORQUE OR EMBED THE BOLT HEAD IN THE BRACKET. THIS WILL VOID MANUFACTURERS WARRANTY.
For further details, refer to the link below.
<https://www.youtube.com/watch?v=IB4apbSEckI&t=13s>

STEP 6 - ATTACH FENDER TO BRACKETS

- A. There are two recommended configurations for fastening the fender to the (10001482) center bracket. If the end of the fender and the center bracket align, fasten the center bracket to the end of the fender using "Option A". If there is a gap between the center bracket and the end of the fender, use "Option B".

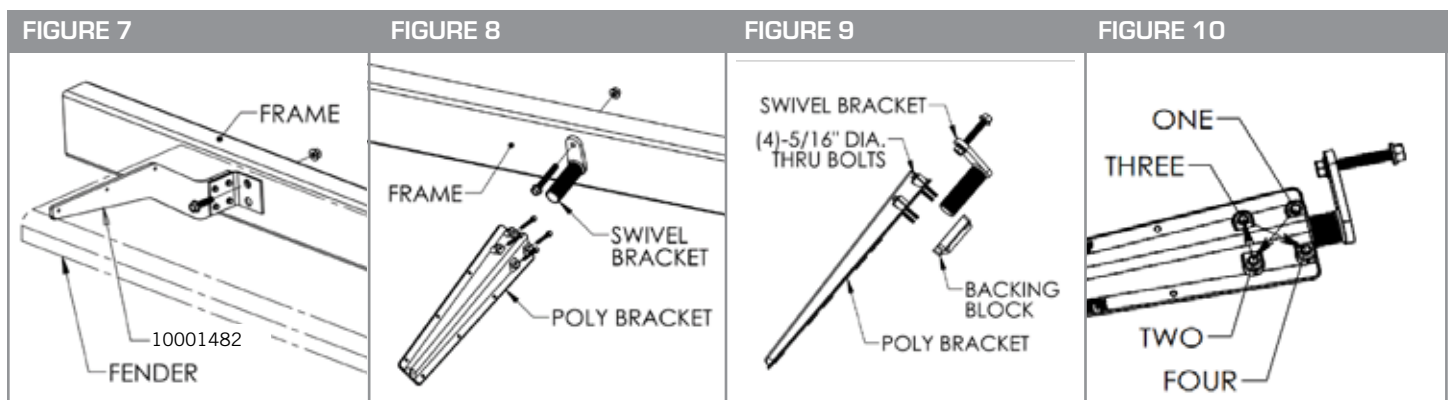

Option A:

- With the fender end up against the (10001482) poly center bracket, drill three 5/16" holes through the fender using the holes in the bracket as a guide.
- Use three 5/16" x 1-1/2" bolts to fasten the center bracket and fenders together.
- Use 5/16" nuts on the inside of the fender.
- **Recommended torque is 10-15 ft.-lbs. (See Figure 11)**

Option B:

- Some installations may not allow the center bracket to fasten to the end of the fender. In these cases, use poly angle (10001483) to connect the fender to the center bracket assembly.
- Use three 5/16" x 1-1/2" bolts to attach the (10001483) poly angle to the center bracket assembly. (Do not tighten bolts until the fender is level.)
- Drill four 5/16" holes through the fender using the holes in the (10001483) poly angle as a guide.
- Use four 5/16" x 1-1/2" bolts to fasten the center bracket and fender together.
- Use 5/16" nuts on the underside of the fender.
- **Recommended torque is 10-15 ft.-lbs. (See Figure 12)**

NOTES:

- (10001483) is also used as a height adjustment aid for the end of the fender. Leave bolts finger tight until you achieve desired height for the fender and check it for level.
- B. Attach the fender to the (10001464) poly bracket.
- a. Verify that the fenders are level across the frame and aligned with the tires for optimal clearance. Fenders that are installed in a deformed or twisted state may lead to material fatigue and reduce the life of the fender.
 - b. Drill six 5/16" holes through the fender using the holes in the (10001464) poly bracket as a guide.
 - c. Install the 5/16" x 1" bolts through the bracket and fender. (See Figure 13)
 - d. Use six 5/16" fender washers and 5/16" nuts provided with the kit on the underside of the fender.
 - e. **Recommended torque is 10-15 FT-LBS. DO NOT EXCEED RECOMMENDED TORQUE.**
For further details, refer to the link in step 5.

FIGURE 11

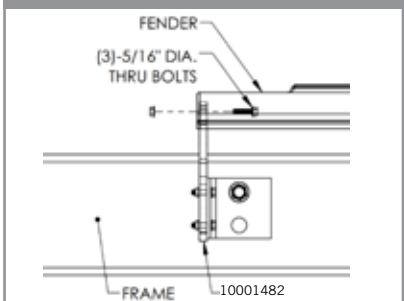

FIGURE 12

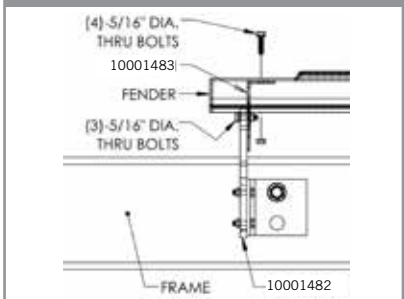
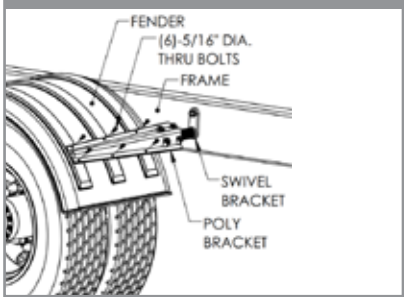

FIGURE 13



STEP 7 - INSPECT AND REPEAT FOR ALL FENDERS

- A. For trucks with air suspension, raise and lower the suspension one final time to confirm that there is adequate clearance between the fenders and wheels.
- B. Repeat the install process for all fenders.
- C. Once fenders are in service, occasionally inspect the 5/8" bolts in the frame to confirm they do not loosen over time.

A DIVISION OF **HIGH BAR BRANDS, LLC**



**HIGH BAR
BRANDS**



2701 18th Street SW, Owatonna, MN 55060
1-800-248-3855 | Fax: 507-583-7540
www.minimizer.com